

# BIA Blokken

De vuilwerk- of schoonwerkblokken zijn er in verschillende druksterktes. De lichtbeton blokken hebben een druksterkte van 15 N/mm<sup>2</sup>. De klinkers verdragen 20 N/mm<sup>2</sup>. Beide blokken zijn geschikt voor (dragende) binnenmuren, scheidingswanden en buitenmuren.

## Maatvaste knipmarkering

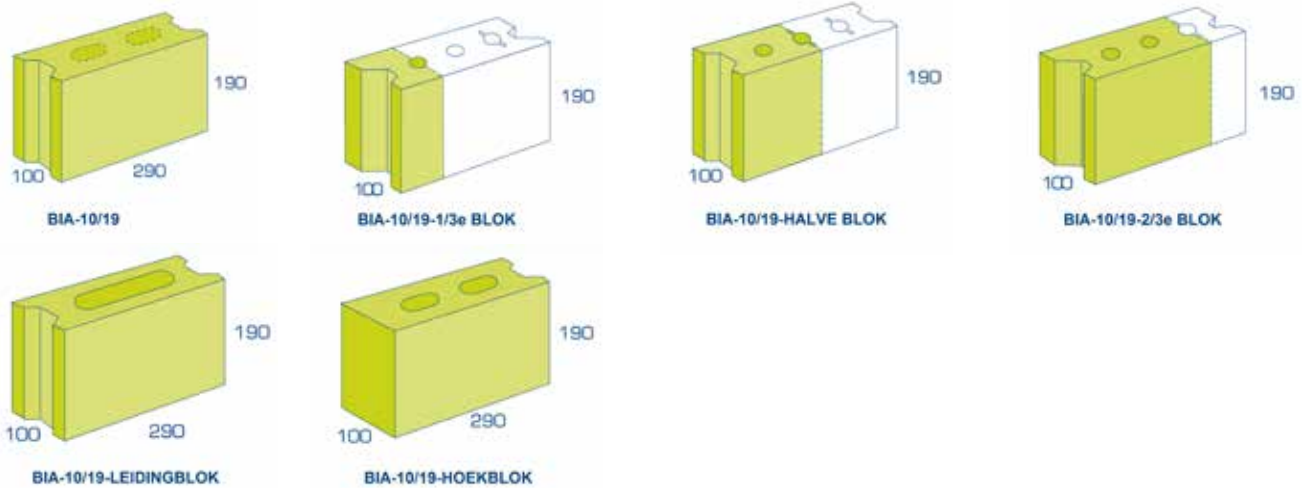







De blokken zijn verkrijgbaar in een hoogte van 19 en 24 cm. BIA levert standaard blokken mee met een knipmarkering op 1/3e en halverwege het blok zodat deze eenvoudig en maatvast kunnen worden geknipt.

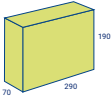
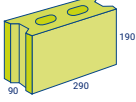
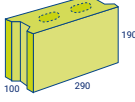
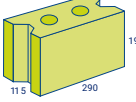
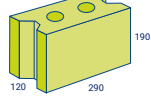
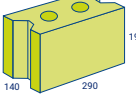

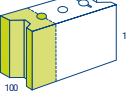
Zoekt u productbladen, verwerkingsinformatie of -advies?  
Kijk dan op: [www.bia-beton.nl](http://www.bia-beton.nl).

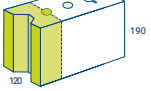

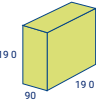
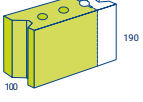
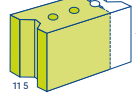
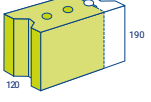
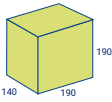
# BIA Blokken hoogte 19 cm

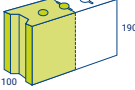
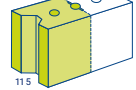
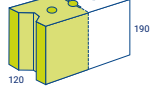
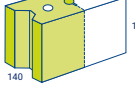
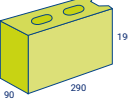
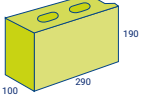
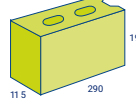
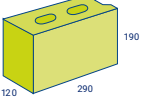
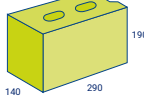
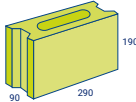
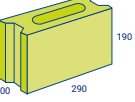
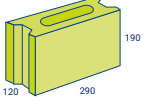
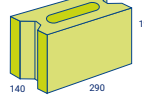
Muur dikte	70	90	100	115	120	140
1/1	 BIA PLAAATJE 7/19	 BIA-9/19	 BIA-10/19	 BIA-11,5/19	 BIA-12/1 9	 BIA-14/19
1/3		 90 90	 100 190	 115 190	 120 190	 140 90
2/3		 90 190	 100 190	 115 190	 120 190	 140 190
1/2		 90 140	 100 190	 115 190	 120 190	 140 190
Hoekblok		 90 290	 100 290	 115 290	 120 290	 140 290
Leidingblok		 90 290	 100 290		 120 290	 140 290

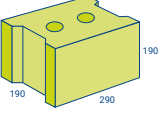
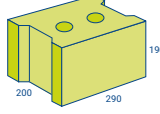
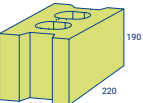
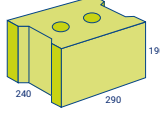
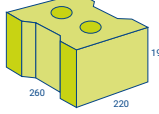
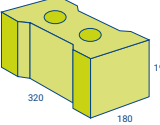
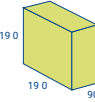
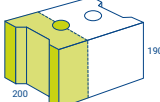
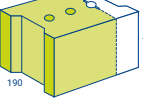
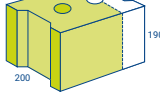
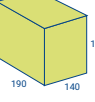
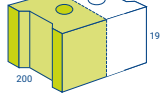
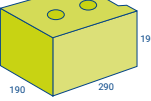
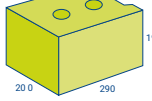
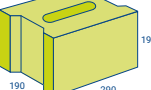
Muur dikte	190	200	240	260	320	
1/1	 BIA-19/19	 BIA-20/19	 BIA-20/19x22	 BIA-24/19	 BIA-26/19	 BIA-32/19
1/3	 190 90	 200 190				
2/3	 190 190	 200 190				
1/2	 190 140	 200 190				
Hoekblok	 190 290	 200 290				
Leidingblok	 190 290					

# BIA Blokken hoogte 24 cm

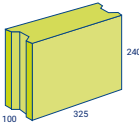
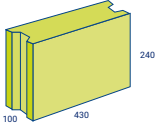
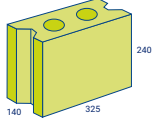
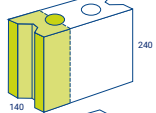
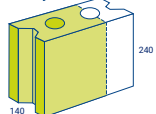
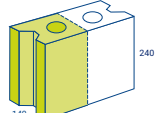
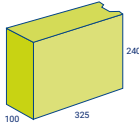
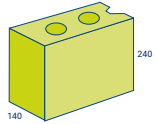
Muur dikte	100	115	120	140
1/1	 <p>BIA-10/24</p>	 <p>BIA-10/24x43</p>		 <p>BIA-14/24</p>
1/3				
2/3				
1/2				
Hoekblok				

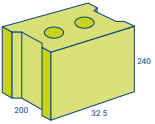
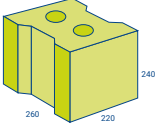
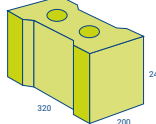
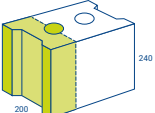
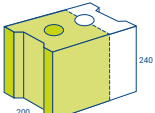
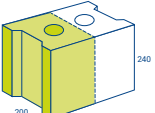
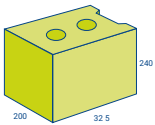
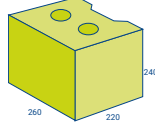
Muur dikte	190	200	240	260	320
1/1		 <p>BIA-20/24</p>	 <p>BIA-26/24</p>	 <p>BIA-32/24</p>	
1/3					
2/3					
1/2					
Hoekblok					



BIA levert standaard blokken mee met een knip markering op 1/3<sup>e</sup> en halverwege het blok zodat deze eenvoudig en maatvast kunnen worden geknipt.

